

## Safety Instructions



0,1,2,3,4,5a,5b,6,7,8,  
9,11,15,20,22,26,27



Info Hotline **+49 (0) 5041 998 389**

Mon. - Do. 7<sup>00</sup> - 20<sup>00</sup>  
Fr. 7<sup>00</sup> - 17<sup>00</sup>

Paulmann Licht GmbH  
31832 Springe / Germany  
www.paulmann.com

Art.-Nr.:

**951.38**

(+MA 173)

PH 02/13 

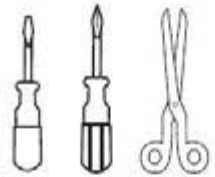
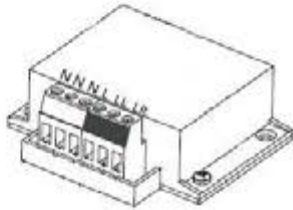

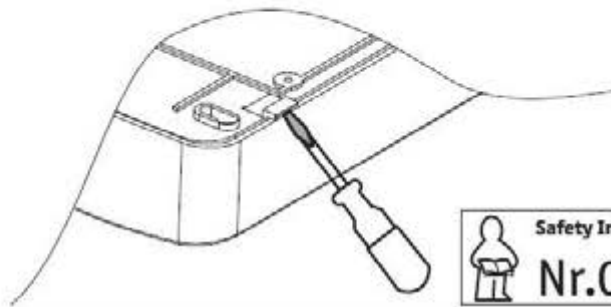

**A**

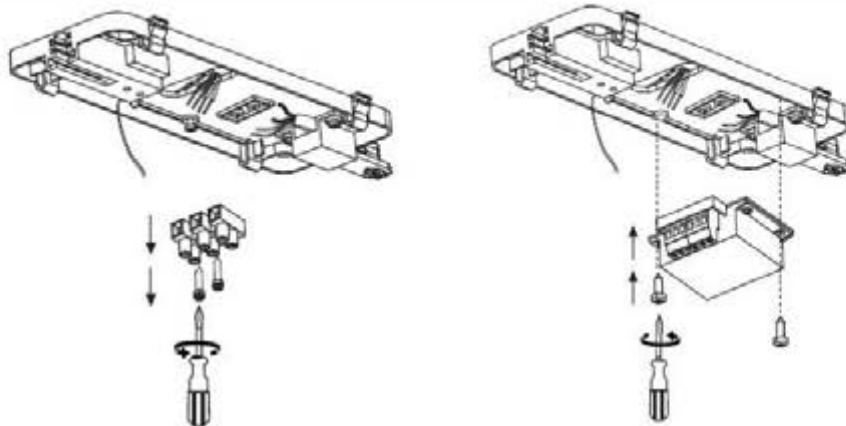

 **Safety Instructions**  
**Nr.0,2**

**B**



 **Safety Instructions**  
**Nr.0,2,3,4**

**C**

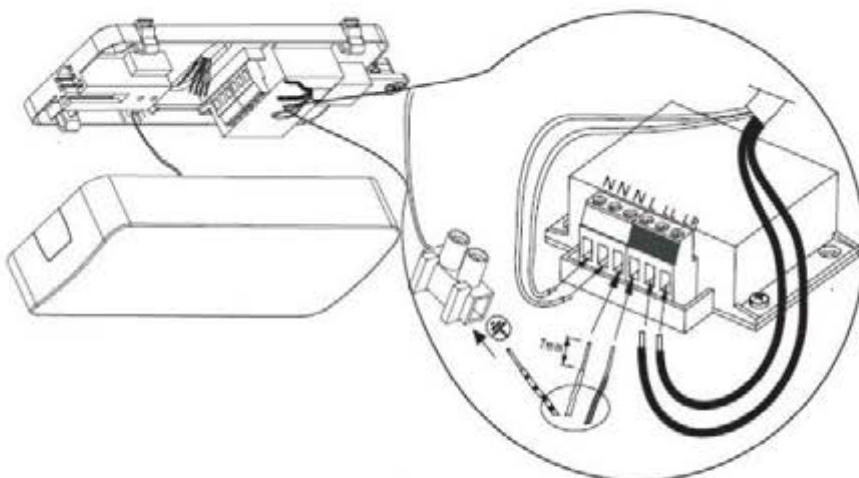

 **Safety Instructions**  
**Nr.0,2,3,4**

